

ECS332 2017/1 Part II.2 Dr.Prapun

4 Amplitude/Linear Modulation

4.1. The big picture:

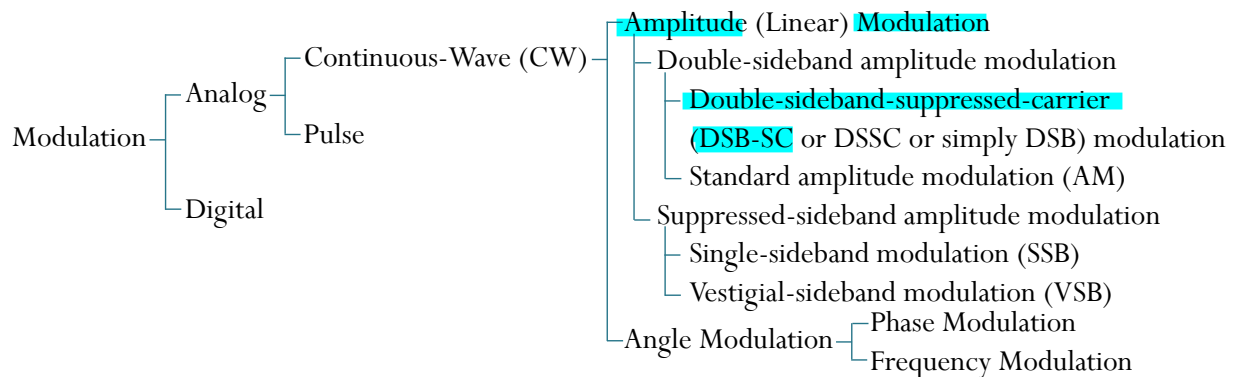

Definition 4.2. A sinusoidal carrier signal $A \cos(2\pi f_c t + \phi)$ has three basic parameters: amplitude, frequency, and phase. Varying these parameters in proportion to the baseband signal results in amplitude modulation (AM), frequency¹⁶ modulation (FM), and phase modulation (PM), respectively.

Collectively, these techniques are called **continuous-wave (CW) modulation** [14, p 111][3, p 162].

¹⁶Technically, the variation of “frequency” is not as straightforward as the description here seems to suggest. For a sinusoidal carrier, a general modulated carrier can be represented mathematically as

$$x(t) = A(t) \cos(2\pi f_c t + \phi(t)).$$

Frequency modulation, as we shall see later, is resulted from letting the time derivative of $\phi(t)$ be linearly related to the modulating signal. [15, p 112]

Definition 4.3. Amplitude modulation is characterized by the fact that the amplitude A of the carrier $A \cos(2\pi f_c t + \phi)$ is varied in proportion to the baseband (message) signal $m(t)$.

- Because the amplitude is time-varying, we may write the modulated carrier as

$$A(t) \cos(2\pi f_c t + \phi) \quad A(t) \propto m(t)$$

- Because the amplitude is linearly related to the message signal, this technique is also called **linear modulation**.

4.1 Double-sideband suppressed carrier (DSB-SC) modulation

Definition 4.4. In **double-sideband-suppressed-carrier** (DSB-SC or DSSC or simply DSB) modulation, the modulated signal is

$$x(t) = A_c \cos(2\pi f_c t) \times m(t). \quad A(t) = A_c m(t)$$

We have seen that the multiplication by a sinusoid gives two shifted and scaled replicas of the original signal spectrum:

$$X(f) = \frac{A_c}{2} M(f - f_c) + \frac{A_c}{2} M(f + f_c).$$

- When we set $A_c = \sqrt{2}$, we get the “simple” modulator discussed in Example 3.13.
- As usual, we assume that the message is band-limited to B .
- We need $f_c > B$ to avoid spectral overlapping. In practice, $f_c \gg B$.

Ex. AM radio $\left. \begin{array}{l} f_c \approx 1 \text{ MHz} \\ B \approx 5 \text{ kHz} \end{array} \right\} \Rightarrow \frac{f_c}{B} = 200$

4.5. Synchronous/coherent detection by the product demodulator:

The incoming modulated signal is first multiplied with a locally generated sinusoid with the same phase and frequency (from a local oscillator (LO)) and then lowpass-filtered, the filter bandwidth being the same as the message bandwidth B or somewhat larger.

4.6. A DSB-SC modem with no channel impairment is shown in Figure 17.

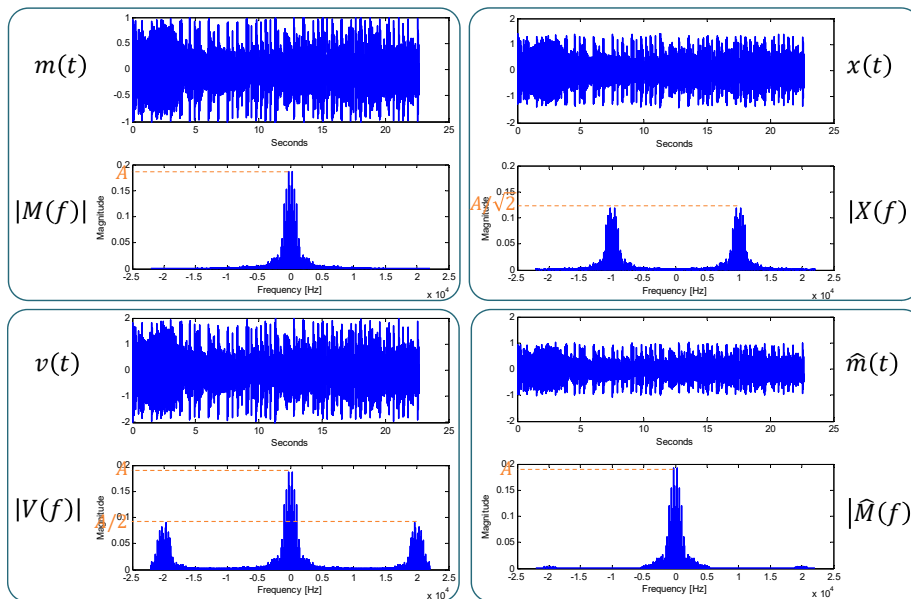
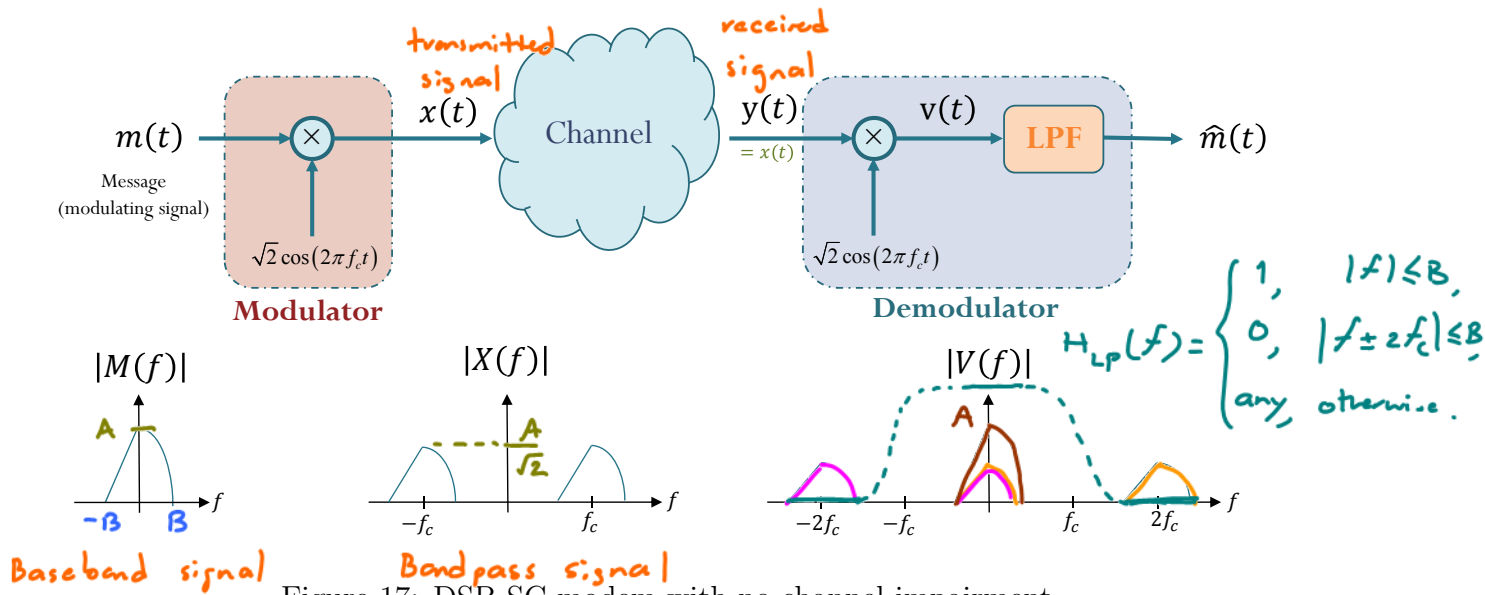

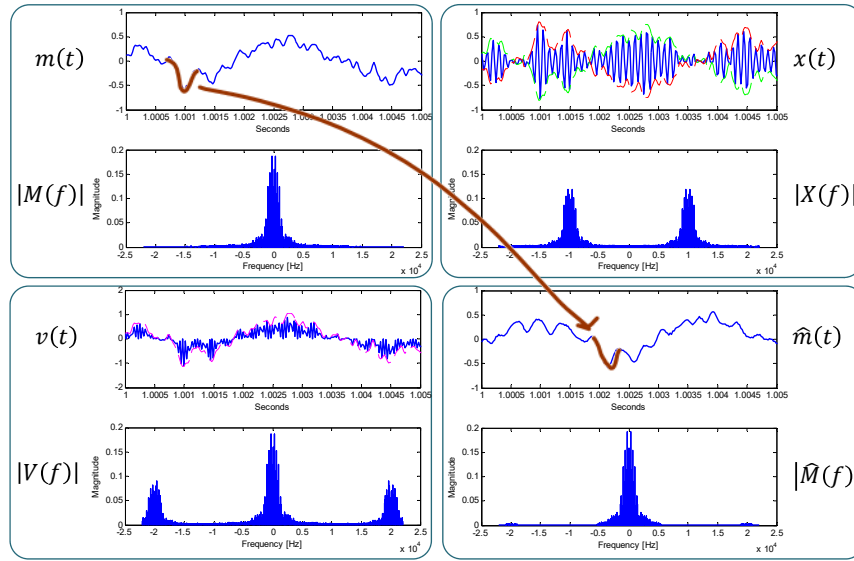

Figure 19: DSB-SC modem: signals and their spectra (zooming in)

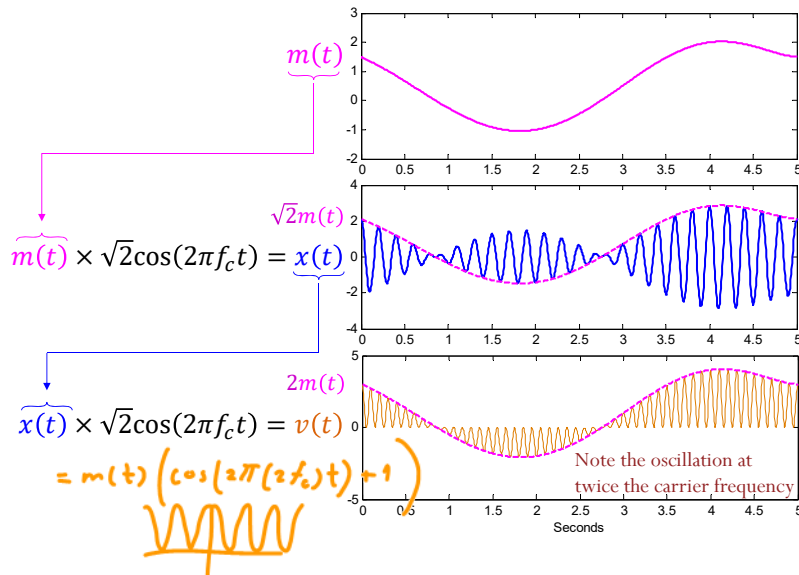

Figure 20: DSB-SC modem: signals in time domain

Once again, recall that

$$X(f) = \sqrt{2} \left(\frac{1}{2} (M(f - f_c) + M(f + f_c)) \right) \\ = \frac{1}{\sqrt{2}} (M(f - f_c) + M(f + f_c)).$$

Similarly,

$$v(t) = y(t) \times \sqrt{2} \cos(2\pi f_c t) = \sqrt{2} x(t) \cos(2\pi f_c t) \\ V(f) = \frac{1}{\sqrt{2}} (X(f - f_c) + X(f + f_c)) \\ = \frac{1}{2} \left(\underbrace{M(f - f_c - f_c)}_{\text{LPF}} + \underbrace{M(f - f_c + f_c)}_{\text{LPF}} \right. \\ \left. + \underbrace{M(f + f_c - f_c)}_{\text{LPF}} + \underbrace{M(f + f_c + f_c)}_{\text{LPF}} \right) \\ \hat{M}(f) = \text{LPF}\{V(f)\} = M(f) + 0 + 0$$

Alternatively, we can work in the time domain and utilize the trig. identity from Example 2.4:

$$v(t) = \sqrt{2} x(t) \cos(2\pi f_c t) = \sqrt{2} \left(\sqrt{2} m(t) \cos(2\pi f_c t) \right) \cos(2\pi f_c t) \\ = 2m(t) \cos^2(2\pi f_c t) = m(t) (\cos(2(2\pi f_c t)) + 1) \\ = m(t) + m(t) \cos(2\pi (2f_c) t)$$

eliminated by LPF

$$\hat{m}(t) = \text{LPF}\{v(t)\} = m(t) + 0$$

Key equation for DSB-SC modem:

$$\text{LPF} \left\{ \underbrace{\left(m(t) \times \sqrt{2} \cos(2\pi f_c t) \right)}_{x(t)} \times \left(\sqrt{2} \cos(2\pi f_c t) \right) \right\} = m(t), \quad (34)$$

where the frequency response of the LPF should satisfy

$$H_{\text{LP}}(f) = \begin{cases} 1, & |f| \leq B, \\ 0, & |f| \geq 2f_c - B, \\ \text{any,} & \text{otherwise.} \end{cases}$$

4.7. Implementation issues:

- (a) Problem 1: Modulator construction
- (b) Problem 2: Synchronization between the two (local) carriers/oscillators
- (c) Problem 3: Spectral inefficiency

4.8. Spectral inefficiency/redundancy: When $m(t)$ is real-valued, its spectrum $M(f)$ has conjugate symmetry. With such message, the corresponding modulated signal's spectrum $X(f)$ will also inherit the symmetry but now centered at f_c (instead of at 0). The portion that lies above f_c is known as the **upper sideband** (USB) and the portion that lies below f_c is known as the **lower sideband** (LSB). Similarly, the spectrum centered at $-f_c$ has upper and lower sidebands. Hence, this is a modulation scheme with **double sidebands**. Both sidebands contain the same (and complete) information about the message.

4.9. Synchronization: Observe that (34) requires that we can generate $\cos(\omega_c t)$ both at the transmitter and receiver. This can be difficult in practice. Suppose that the frequency at the receiver is off, say by Δf , and that the phase is off by θ . The effect of these frequency and phase offsets can be quantified by calculating

$$\text{LPF} \left\{ \left(m(t) \sqrt{2} \cos(2\pi f_c t) \right) \sqrt{2} \cos(2\pi (f_c + \Delta f) t + \theta) \right\},$$

which gives

$$m(t) \cos(2\pi (\Delta f) t + \theta).$$

When Δf is small, the "cos" factor will scale the message
↳ could be near 0 for a while (periodically)
When $\Delta f = 0$ but $\theta = 90^\circ, 270^\circ, \dots$, "cos" = 0 at all time!!

Of course, we want $\Delta\omega = 0$ and $\theta = 0$; that is the receiver must generate a carrier in phase and frequency synchronism with the *incoming carrier*.

4.10. Effect of time delay:

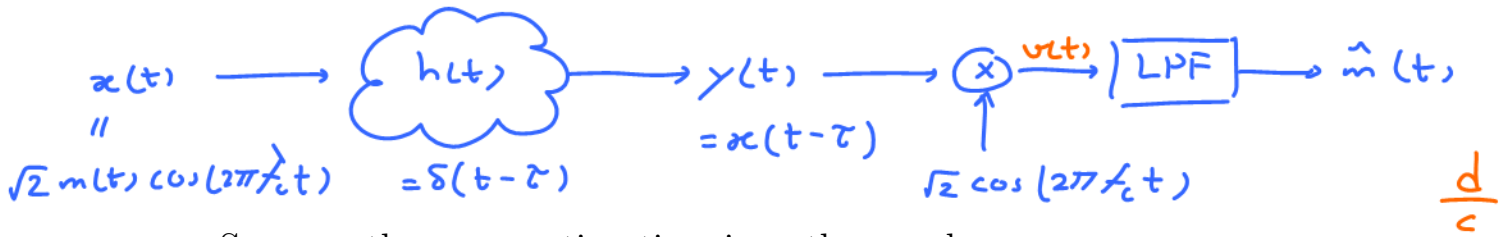

Suppose the propagation time is τ , then we have

$$\begin{aligned} y(t) &= x(t - \tau) = \sqrt{2}m(t - \tau) \cos(2\pi f_c(t - \tau)) \\ &= \sqrt{2}m(t - \tau) \cos(2\pi f_c t - 2\pi f_c \tau) \\ &= \sqrt{2}m(t - \tau) \cos(2\pi f_c t - \phi_\tau) \end{aligned}$$

Define

$$\phi_\tau = 2\pi f_c \tau$$

↑
phase shift

"
time delay

Consequently,

$$\begin{aligned} v(t) &= y(t) \times \sqrt{2} \cos(2\pi f_c t) \\ &= \sqrt{2}m(t - \tau) \cos(2\pi f_c t - \phi_\tau) \times \sqrt{2} \cos(2\pi f_c t) \\ &= m(t - \tau) 2 \cos(\underbrace{2\pi f_c t - \phi_\tau}_A) \cos(\underbrace{2\pi f_c t}_B) \end{aligned}$$

Applying the product-to-sum formula, we then have

$$v(t) = m(t - \tau) (\cos(\underbrace{2\pi(2f_c)t - \phi_\tau}_{A+B}) + \cos(\underbrace{\phi_\tau}_{A-B}))$$

$$= m(t - \tau) \cos(\phi_\tau) + m(t - \tau) \cos(2\pi(2f_c)t - \phi_\tau)$$

eliminated by LPF

$$\hat{m}(t) = \text{LPF}\{v(t)\} = m(t - \tau) \cos(\phi_\tau) + 0$$

↳ could be bad @ some distance

$$2\pi f_c \tau = \phi_\tau = \frac{\pi}{2} + k\pi, \quad k \text{ can be any integer}$$

$$\frac{d}{c} = \tau = \frac{1}{4f_c} + \frac{k}{2f_c} \Rightarrow d = \frac{c}{4f_c} + \frac{k c}{2f_c} = \frac{\lambda_c}{4} + \frac{\lambda_c}{2} k$$

In conclusion, we have seen that the principle of the DSB-SC modem is based on a simple key equation (34). However, as mentioned in 4.7, there are several implementation issues that we need to address. Some solutions are provided in the subsections to follow. However, the analysis will require some knowledge of Fourier series which is reviewed in Section 4.3.